



International Journal of Innovative Research in Science Engineering and Technology (IJIRSET)

(A Monthly, Peer Reviewed, Refereed, Scholarly Indexed, Open Access Journal)



Impact Factor: 8.699

Volume 14, Issue 4, April 2025

A New Gradient Adaptive Smart Path Way Cleaning Robot

**Dr.M.Sivachitra¹, T Kishan Chakravarthy², R Kishore³, B Madhav Harish⁴, M Sanjayarasu⁵,
Dr.N.Saravanakumar⁶**

Department of Electrical and Electronics Engineering, Kongu Engineering College, Erode, India

ABSTRACT: The greater use of ramps in contemporary buildings requires effective and automated cleaning mechanisms to preserve hygiene in public places like malls, hospitals, and office buildings. This work reports the invention of an autonomous ramp-cleaning robot aimed at making maintenance less labour-intensive and more efficient. The robot comes with advanced mobility features to clean sloping surfaces effectively, delivering consistent and even cleaning performance. One of the most prominent features of the system is the incorporation of ultrasonic sensors for real-time obstacle detection and evasion, which maximizes operational safety and responsiveness in dynamic environments. The cleaning system includes a high-efficiency vacuum system for the removal of dust and debris, supplemented by a sanitizer sprayer to ensure hygienic condition especially important in healthcare and public areas. The robot's advanced navigation system maximizes its cleaning route, minimizing power usage while providing complete coverage. Versatile in design, the robot is compatible with different ramp designs and can run freely with limited user intervention.

Its lightweight and small form factor allows for transparent integration into commercial and institutional environments without affecting normal operations. The system also accommodates remote monitoring and control through smart home and facility management networks, further improving user convenience. Moreover, software updates allow continuous enhancement using user input and changing architectural needs. This innovation is a major leap forward in automated cleaning technologies, answering the increasing need for effective and sanitary maintenance practices in public and commercial environments. Through the elimination of manual labour and enhanced effectiveness in cleaning, the proposed new gradient adaptive robot system helps achieve safer and healthier conditions.

I. INTRODUCTION

The New Gradient Adaptive Smart Pathway Cleaning Robot is a solution for cleaning sloping surfaces in high-traffic commercial facilities like hospitals, shopping malls, and public buildings. Cleaning sloping surfaces traditionally is cumbersome, time-consuming, and inefficient and tends to be ineffective in cleaning away settled dust and debris. Maintaining hygiene in these settings is vital to public health, and robotic automation is an appropriate and effective alternative. By using intelligent navigation and dual-action cleaning mechanisms, the Gradient-Cleaning Robot avoids manual intervention while offering consistent and deep cleaning[10].

The main goal of this work is to create a self-sustaining robotic system that can effectively clean sloped surfaces. For this purpose, the robot has a rocker-bogie suspension system, which was originally conceived for space exploration and offers better stability and traction on slopes. Furthermore, ultrasonic sensors are incorporated for real-time detection of obstacles and collision avoidance to provide safe movement in dynamic settings. These functionalities allow the robot to balance, adjust to irregular surfaces, and clean effectively without the possibility of falling over. The cleaning system has a two-way mechanism involving an industrial vacuum motor for dust removal and a sanitizer sprayer for microbial sanitation. The vacuum picks up dust and debris efficiently, while the sprayer sprays disinfectant, leaving the surface hygienic. This self-activation minimizes human intervention, and cleaning processes are cost-saving, dependable, and productive. The lightweight, portable, and fully automated robot design guarantees increased safety and hygiene in commercial and institutional settings.

II. LITERATURE SURVEY

A. Related Works

Ilyas et al. (2018) introduced **Tetro**, a modular, reconfigurable, and autonomous staircase-cleaning robot designed for efficient cleaning operations in structured environments. The robot integrates a flexible modular system that allows adaptation to different staircase dimensions and inclinations. The study highlights the significance of reconfigurability in improving efficiency and coverage during cleaning tasks. The proposed design utilizes an autonomous navigation system to ensure smooth transitions across stair edges, optimizing cleaning performance without human intervention[11].

Zhou, Wu, and Wang (2021) presented a novel approach for mobile robots navigating steep slopes through propulsion adhesion. Their research emphasized the importance of adhesion-based propulsion systems in maintaining stability and traction on inclined surfaces. The proposed robot was designed to overcome extreme terrains by dynamically adjusting its adhesion mechanisms, ensuring secure movement across steep environments. This study is particularly relevant for applications requiring robust mobility in challenging outdoor conditions, such as maintenance and inspection tasks[12]. Guo and Chai (2020) explored practical techniques for improving quadruped robots' climbing abilities on steep slopes. Their research, presented at the IEEE International Conference on Robotics and Automation (ICRA), focused on developing control strategies and mechanical adaptations to enhance stability and locomotion efficiency. The study provided insights into gait planning and dynamic balancing, demonstrating how quadruped robots can navigate inclines while maintaining structural integrity and mobility[13].

Smith et al. (2024) introduced **ALPINE**, a climbing robot designed for operations in mountainous environments. The robot leverages advanced locomotion strategies and environmental sensing to maneuver through rugged terrain. Their research, published as an arXiv preprint, discusses the challenges of developing a robot capable of withstanding extreme outdoor conditions while maintaining precise movement control. The findings contribute to the broader field of mobile robotics by offering solutions for terrain adaptability and energy-efficient climbing[14].

Shirai et al. (2022) proposed a framework for simultaneous contact-rich grasping and locomotion, enabling free-climbing capabilities for multi-limbed robots. Their study employed distributed optimization techniques to enhance robot interaction with surfaces, ensuring optimal grasping and movement coordination. The research provides valuable insights into bio-inspired locomotion, where multi-limbed robots mimic natural climbing behaviors for enhanced maneuverability in challenging environments[15].

B. Problem Statement

Cleaning ramps in public, medical, and business buildings is a labor-intensive and time-consuming process when done manually. Ramps trap dust, dirt, and debris because of constant foot traffic, so regular cleaning is critical to ensure hygiene and safety. Conventional cleaning is usually less than ideal and uneven and has difficulty navigating on sloping surfaces, clearing obstructions, and thorough sanitizing, especially in high-traffic areas such as hospitals and malls. The dependence on human labor adds to operational inefficiencies and costs as well. Thus, the proposed new gradient adaptive robot **system** can effectively clean ramps without compromising on dust removal, detection of obstacles, and sanitization with minimal human involvement is necessary.

III. PROPOSED METHODOLOGY

A. Components Used

The parts utilized are the 12V Centre Shaft DC Geared Motor, Arduino Nano, HC-05 Bluetooth Module, L298 Motor Driver, Vacuum Motor, 6V Pump Motor with Sprayer, and HC-SR04 Ultrasonic Sensor. The 12V Centre Shaft DC Geared Motor[1] delivers steady torque and travel over slopes, providing smooth movement. It is structured to support the weight of the robot without tipping over on slopes, slipping, or jerking. Moreover, its capability for high torque ensures smooth and stable movement, even on bumpy terrain. The Arduino Nano[2] is the core controller, receiving sensor data and issuing motor commands in real-time. It ensures proper communication between the parts to enable the robot to react optimally to changing surroundings.

The HC-05 Bluetooth Module[3] facilitates wireless communication, remote control of the robot through a smartphone or other Bluetooth devices. This functionality allows for flexibility in operation, as it is easy for users to guide and

control the robot's functions without manual intervention. The L298 Motor Driver[4] controls motor speed and direction, providing accurate movement and maneuverability. It provides independent motor control, allowing the robot to turn, change speed, and move through different obstacles effectively. The Vacuum Motor picks up dust and dirt, increasing the cleaning power by efficiently sucking dirt from stairs and surfaces. It is made to operate effectively while using low energy, ensuring extended use.

6V Pump Motor with Sprayer[6] dispenses sanitizing liquids for better cleaning to make surfaces not only dust-free but also disinfected. It is especially advantageous in places where deep cleaning is needed, like hospitals or public areas. HC-SR04 Ultrasonic Sensor[5] scans for edges and obstacles and assists the robot in moving freely and without collision. It continuously monitors the environment and delivers instant feedback to the Arduino such that the robot remains within its defined cleaning zone. The sensor is also used to detect stair edges to avoid the robot falling off and being damaged. The components combined allow the robot to clean and move across different terrains automatically, making its performance in structured and unstructured environments optimal with minimal intervention by humans.

Block Diagrams

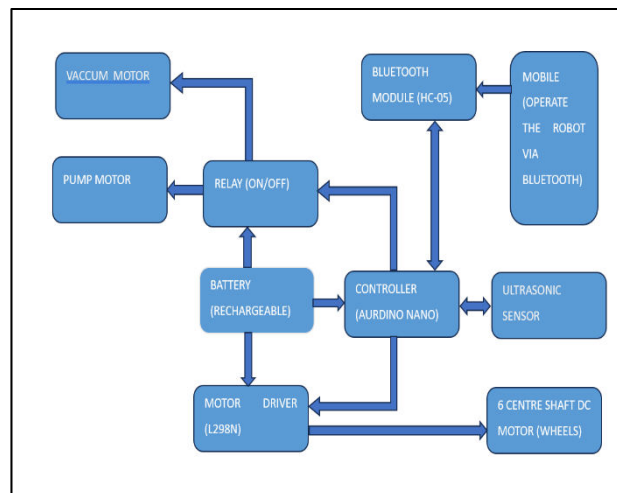

Fig.3.1 Block Diagram

The block diagram depicts the system architecture of the robot, describing the interaction among different hardware components. The Arduino Nano is at the center of the system, which is the main microcontroller tasked with processing sensor data, issuing motor commands, and managing cleaning operations. The HC-05 Bluetooth module facilitates wireless connectivity between the robot and a mobile device, enabling remote operation of movement and cleaning capabilities. The communication interface increases system usability and flexibility with ease of operation without physical contact.

The ultrasonic sensor HC-SR04 is vital in edge detection and obstacle avoidance, delivering real-time distance reading to the controller. This provides safe passage by avoiding any collision of the robot with other objects or against edges. L298 motor driver is used for the control of 12V center shaft DC geared motors that power the wheels and facilitate mobility on sloped surfaces. Modulating the direction and speed of the motors enables the robot to move smoothly through slopes as well as any other irregular grounds, with support during movement.

In cleaning operations, the system has a vacuum motor and a 6V pump motor with sprayer, both of which are driven by a relay module. Vacuum motor takes care of dust and dirt collection, while pump motor sprays liquid cleaning agents on surfaces to clean them thoroughly. The relay module is an electronic switch that turns these cleaning devices on or off according to the instructions of the controller. This guarantees energy-efficient operation, since cleaning mechanisms are only turned on when required.

Powering the entire system is a rechargeable battery, which supplies the necessary voltage and current to all components. The battery ensures uninterrupted operation, allowing the robot to function autonomously for extended

periods. By integrating motor control, sensor-based navigation, and automated cleaning processes, the robot achieves efficient and reliable performance. This modular design enhances adaptability, making it suitable for diverse cleaning applications in residential and commercial environments.

B. Circuit Diagram

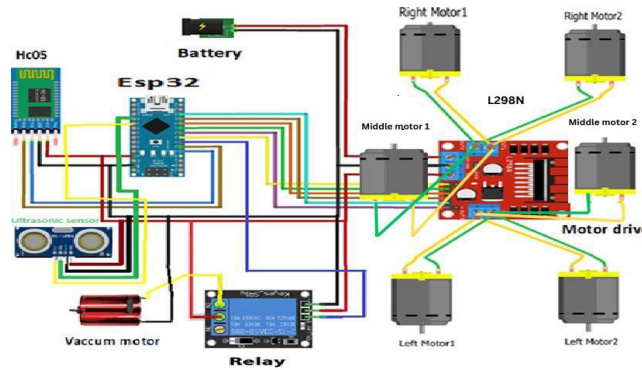
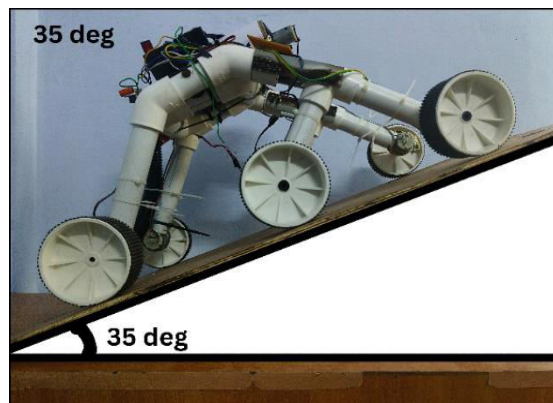

Fig.3.2 Circuit Diagram

The diagram is used to represent the robot, with key components like the Arduino Nano microcontroller, L298N motor driver, HC-05 Bluetooth module, HC-SR04 ultrasonic sensor, vacuum motor, relay module, water pump motor with sprayer, and battery power supply. The Arduino Nano acts as the core processing unit, and it manages the control of motors, processing sensor information, and wireless communication. The HC-05 Bluetooth module is interfaced to the Arduino Nano's RX (D0) and TX (D1) pins to use a smartphone as a remote. The HC-SR04 ultrasonic sensor is interfaced at D3 (Echo) and D2 (Trigger) for real-time object detection for safe navigation.

The L298N motor driver manages the six DC motors, which provide a smooth movement. The Arduino Nano drives signals of D5, D6, D9, and D10 to the L298N's IN1, IN2, IN3, and IN4 pins, which control the speed and direction of the motors. The motors are driven through the L298N's OUT1, OUT2, OUT3, and OUT4 terminals, providing stability on steep surfaces. The motor driver is supplied with a 12V battery, which provides enough torque for movements. For cleaning purposes, the vacuum motor is regulated by a relay module on pin D7 to facilitate dust collection. A 6V water pump motor with a sprayer has also been incorporated for sanitizing purposes. The pump motor is regulated by another relay module on pin D8 of the Arduino Nano. This relay facilitates the sprayer to be triggered when necessary, effectively dispensing cleaning liquid on surfaces.

Here, the Arduino Nano reads sensor data, manages motor movement, and engages cleaning systems smartly. The L298N provides motor efficiency, with vacuum and pump motors controlled via relays that allow for two-stage cleaning—dust collection and sterilization. The system is completely autonomous but can be accessed remotely through Bluetooth, making it a smart and efficient cleaning solution.



IV. RESULT AND DISCUSSION

A. Hardware Implementation

The ramp cleaning robot is capable of working effectively at different incline angles, with the best performance in different environments. Its sophisticated rocker-bogie system, adjustable suspension system, and careful weight distribution allow it to have stability, traction, and cleaning efficiency even on difficult slopes. The subsequent analysis illustrates the robot's performance at different incline angles[7].

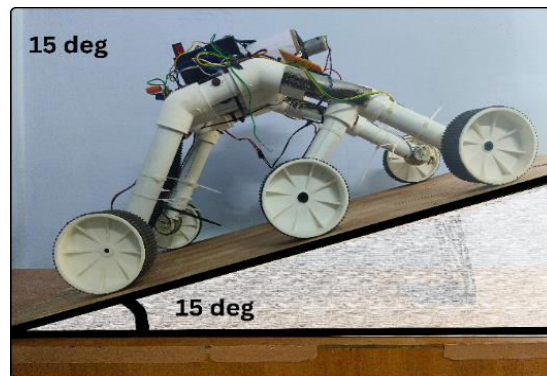

Fig.4.1 Inclined angle of 15°

On a 15° incline, the robot shows incredible stability with low resistance to movement, providing steady and smooth movement. This capability makes it an ideal choice for such gentle slopes as parking ramps, walkways, and sloping paths typical of commercial locations. With low motor strain, the robot effectively saves energy while effectively picking up debris to provide peak cleaning performance in less demanding applications.

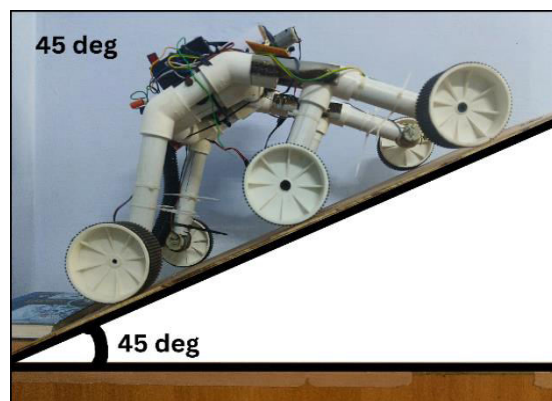

Fig.4.2 Inclined angle of 25°

When running at an angle of 25°, the rocker-bogie system of the robot excels by spreading its weight evenly, which provides greater traction and ensures that all the wheels remain in firm contact with the surface. This equalized design really enhances stability and grip, and the robot is able to drive over moderately sloping surfaces like industrial ramps and loading docks efficiently and confidently.

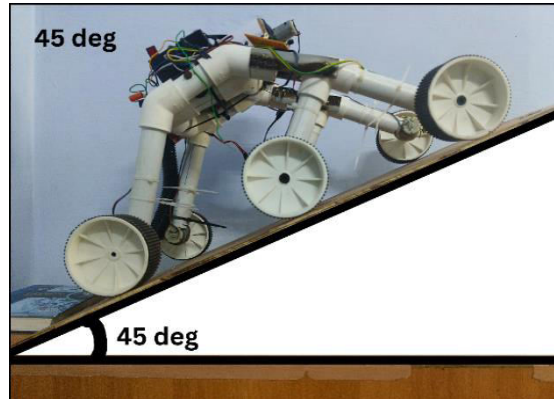

Fig.4.2 Inclined angle of 35°

At 35°, the robot faces a major slope increase requiring higher stability and control. The robot's suspension system steps in here to address this by dynamically adjusting the placement of its wheels for optimal surface contact. This adaptive mechanism is important in helping to maintain traction, particularly on uneven or debris-covered surfaces where skidding or slipping is more eminent.

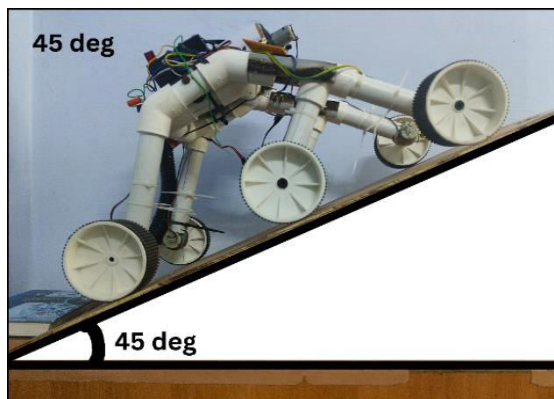

Fig.4.2 Inclined angle of 45°

For very steep inclines of 45°, the robot uses its sophisticated wheel design and planned weight distribution to ensure efficient traction and balance. Through optimized motor torque and the application of fine traction control, the robot surmounts higher resistance without compromising stability. This rugged performance renders it extremely efficient for traversing steep ramps, uneven pathways, and challenging outdoor terrain where dependability is critical.

B. Controls

Table 4.1 Robot input commands and its movements

INPUT	MOVEMENT
A	FORWARD
B	BACKWARD
C	LEFT
D	RIGHT
E	STOP

F	VACUUM
G	SPRAYER

The robot's motion is regulated by a basic set of input commands, each triggering a particular action. Inputs "A" and "B" facilitate forward and backward motion, enabling effective movement along ramps. Inputs "C" and "D" regulate left and right turns, enabling the robot to turn around corners or move its position. Input "E" halts all motion for safety and control. In addition to simple commands, inputs "F" and "G" activate the vacuuming and sprayer systems for intense dust removal and sanitizing[9].

C. Outcome

Slope Angle	Time
15'	33 sec
25'	37 sec
35'	41 sec
45'	49 sec

Table 4.2 Slope angle with respect to climbing time

The Gradient-Cleaning Robot was examined for climbing efficiency on different slopes, with a constant travel distance of 100 cm. The outcomes show an incremental rise in time as the angle of incline rises, revealing the influence of slope steepness on mobility performance. The robot climbed to a 15-degree slope and reached the top in 33 seconds, revealing low resistance and good traction. As the incline was raised to 25 degrees, the ascend time was also increased to 37 seconds, indicating a minute reduction in mobility because of additional gravitational resistance. Additional testing with 35 degrees took 41 seconds to accomplish the climb, and the highest tested incline of 45 degrees took 49 seconds to reach the summit. These findings confirm the robot's ability to operate under different inclinations successfully, showing the effectiveness of the rocker-bogie suspension mechanism in staying stable and controlled in movement. The increasing time factor indicates the anticipated effect of increasing angles on motor performance and traction. Generally, the findings assert that the robot is optimized for sloped surface cleaning with consistent and reliable movement regardless of inclination.

D. Future Scope

The ramp-cleaning robot's future holds promising potential for improvement. The addition of sophisticated sensors such as ultrasonic, infrared, or LiDAR would enhance obstacle detection and navigation, allowing for effective cleaning on various ramp inclines without accidents. A mapping function would allow the robot to remember layouts, maximizing cleaning efficiency with time and making it more responsive to real-world environments.

Machine learning integration would also improve cleaning performance by studying previous sessions, identifying patterns of dirt accumulation, and adapting speed, suction, and cleaning intensity accordingly. This flexibility would enable the robot to adapt to various ramp surfaces and optimize cleaning strategies. Furthermore, gathering user input and performance metrics would help the robot continuously optimize its efficiency and effectiveness.

Adding features like wet cleaning, dust sensing, and IoT-based remote control using a mobile app would add to its functionality. Autonomous charging, self-maintenance, and compatibility with smart building systems could make the robot a completely automated cleaning solution, making commercial and institutional maintenance more effective and intelligent.

V. CONCLUSION

In summary, the new gradient adaptive smart pathway cleaning robot system successfully combines diverse electronic components and systems to serve its main function of autonomous cleaning. Through the use of an Arduino Nano as the main controller, the robot is able to receive instructions remotely through the HC-05 Bluetooth module, which enables easy remote control. The application of a 6V 4.5Ah rechargeable sealed lead acid battery ensures a constant power supply, thus allowing the robot to carry out its functions for prolonged periods without frequent breaks. Smooth and

controlled motion is enabled by the L298 motor driver, allowing the robot to move along ramps and obstacles with efficiency.

The integration of these elements demonstrates the flexibility and utility of contemporary robotics. The paper not only demonstrates the capability of automation in ramp cleaning but also provides an educational platform for learning the concepts of electronics, programming, and mechanical design. As technology advances, such robots open the door to new developments in robotic systems, calling for new applications and better efficiency and performance.

REFERENCES

1. Zhu Haishui ., Wang Dahu., Zhang Tong., Huang Keming(2010)" Design on a DC Motor Speed Control" International Conference on Intelligent Computation Technology and Automation,10.1109/ICICTA.2010.795
2. Hani Al-Mimi , Ali Al-Dahoud1 , Mohamed FEZARI, Mohammad Sh. Daoud(2020)" A Study on New Arduino NANO Board for WSN and IoT Applications" International Journal of Advanced Science and Technology Vol. 29, No. 4.
3. Rohani Amrin , Md. Manik Ahmed , Ariful Islam , Abdullah Al Zubaer, Md. Mehedi Hasan Naim(2020) "Design and Development of Bluetooth Controlled Car Using Bluetooth Module HC-05" GSJ: Volume 8, Issue 9, ISSN 2320-9186.
4. Azhari, T I Nasution and P F A Azis(2023) "MPU-6050 Wheeled Robot Controlled Hand Gesture Using L298N Driver Based on Arduino" Journal of Physics: Conference Series, Volume 2421, 2nd TALENTA-International Conference on Science and Technology J.Phys.: Conf. Ser. 2421 012022
5. Carullo, A., & Parvis, M. (2001). "An Ultrasonic Sensor for Distance Measurement in Automotive Applications." IEEE Sensors Journal, 1(2), 143-147.
6. S. A. Austin, C. I. Goodier , P. J. Robins (2005) "Low-volume wet-process sprayed concrete: pumping and spraying" Materials and Structures 38 - 229-237
7. D. S. Chinchkar, S. S. Gajghate, R. N. Panchal, R. M. Shetenawar, P. S. Mulik(2017) "Design of Rocker Bogie Mechanism" National Conference on Design, Manufacturing, Energy & Thermal Engineering (NCDMETE-2017) Vol. 4, Special Issue 1, January 2017
8. Khadse, K. H., Wagh, S. K., and Gawande, P. S. (2018) "Implementation of Speech Based Home Automation System Using Bluetooth," in 2018 3rd International Conference on Intelligent Computing and Control Systems (ICICCS), pp. 555 - 560.
9. Chaoqun Wang; Min Xia; Max Q.-H. Meng(2020) "Stable Autonomous Robotic Wheelchair Navigation in the Environment With Slope Way" IEEE Transactions on Vehicular Technology (Volume: 69, Issue: 10,)
10. M. W. Spong and M. Vidyasagar, "Adaptive Control of Robot Manipulators Using a Gradient Descent Method," Proceedings of the 1985 American Control Conference, pp. 1883-1887, 1985.
11. Ilyas, M., Yuyao, S., Mohan, R. E., Devarassu, M., and Kalimuthu, M. (2018) "Design of Tetro: A Modular, Reconfigurable, and Autonomous Staircase Cleaning Robot," IEEE Robotics and Automation Letters, vol. 3, no. 4, pp. 3441-3448.
12. J. Zhou, H. Wu, and Y. Wang(2021), "Development of a steep slope mobile robot with propulsion adhesion," IEEE Access, vol. 9, pp. 35422-35434.
13. X. Guo and L. Chai(2020), "Practical techniques research on climbing the steep slope of quadruped robots," in Proc. IEEE Int. Conf. Robot. Autom. (ICRA), pp. 2857-2863.
14. L. Smith et al.(2024), "ALPINE: A climbing robot for operations in mountain environments," arXiv preprint arXiv:2403.15142.
15. Y. Shirai, X. Lin(2022), A. Schperberg, Y. Tanaka, H. Kato, V. Vichathorn, and D. Hong, "Simultaneous Contact-Rich Grasping and Locomotion via Distributed Optimization Enabling Free-Climbing for Multi-Limbed Robots," arXiv preprint arXiv:2207.01418.



INTERNATIONAL
STANDARD
SERIAL
NUMBER
INDIA



INTERNATIONAL JOURNAL OF INNOVATIVE RESEARCH

IN SCIENCE | ENGINEERING | TECHNOLOGY

 9940 572 462  6381 907 438  ijirset@gmail.com



www.ijirset.com

Scan to save the contact details